

Data Sheet



Article number: 03441100

Description: Fluro Rod end GE 100EC-2RS

Measures

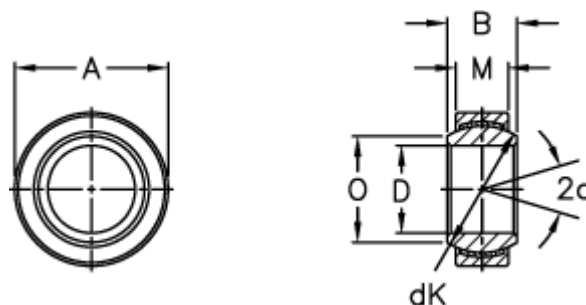

A = 150 0 -0,018

B = 70

D = 100 0 -0,020

dK = 130

Dynamic load C (kN) = 1145

M = 55

O = 109.5

Static load C0 (kN) = 2290

Tilt angle = 7

Weight = 4400